

 Hollyland(China)Electronics Technology Corporation Limited	PRODUCT SPECIFICATION	ISSUED DATE: 2011/11/5	2011/11/5
	HBC RoHS SERIES	REV. NO.: A02 DOC. NO.: HLD-PSI-504 PAGE : Page 1 of 5	A02 HLD-PSI-504 Page 1 of 5

制定 PREPARED BY		审核 CHECKED BY		批准 APPROVED BY	
-------------------	---	------------------	---	-------------------	---

1. 适用范围/ SCOPE **朱泽江**

本规格书适用于本公司生产的 HBC aR RoHS series HOLLY® 商标的螺栓连接型熔断体。

This specification defines the technical requirements of fuse-links with bolted connections type HBC aR series with HOLLY® brand.

产品部件号为: 型号 额定电流
 Construction of part no: type rated current
 例如 For Example: HBC 40A

产品部件号 PART NUMBER

目录编号 Part No.	额定电流 Rated Current	额定电压 Rated Voltage	目录编号 Part No.	额定电流 Rated Current	额定电压 Rated Voltage
HBC35	3 5 A	500V AC 500V DC	HBC225	2 2 5 A	500V AC 500V DC
HBC40	4 0 A		HBC250	2 5 0 A	
HBC45	4 5 A		HBC275	2 7 5 A	
HBC50	5 0 A		HBC300	3 0 0 A	
HBC60	6 0 A		HBC325	3 2 5 A	
HBC70	7 0 A		HBC350	3 5 0 A	
HBC80	8 0 A		HBC400	4 0 0 A	
HBC90	9 0 A		HBC450	4 5 0 A	
HBC100	1 0 0 A		HBC500	5 0 0 A	
HBC125	1 2 5 A		HBC600	6 0 0 A	
HBC150	1 5 0 A		HBC700	7 0 0 A	
HBC175	1 7 5 A		HBC800	8 0 0 A	
HBC200	2 0 0 A		/	/	

2. 相关标准及认证情况 APPLICABLE STANDARDS & APPROVED DETAILS

2.1 HBC aR RoHS 系列产品适用的相关标准是 IEC 60269-4, GB/T13539.4.

Applicable standards for HBC aR RoHS series are IEC 60269-4 and GB/T 13539.4.

3. 公司地址 ADDRESS

中国福建省厦门市湖里区枋湖路 9-19 号

NO. 9-19, FANGHU ROAD, HULI, XIAMEN, FUJIAN, CHINA.

4. 构造图 CONSTRUCTION FIG. & DIMENSION

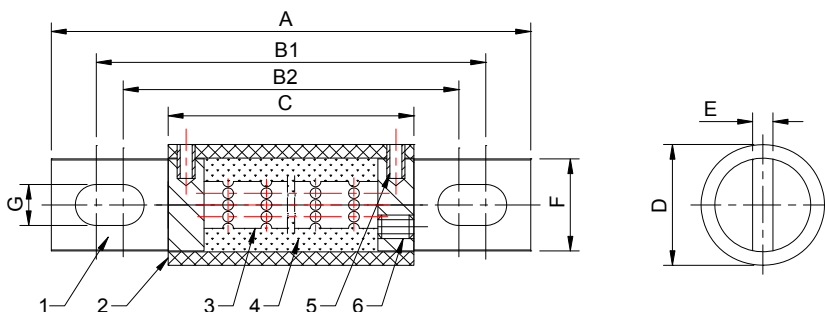

 Hollyland(China)Electronics Technology Corporation Limited	PRODUCT SPECIFICATION	ISSUED DATE: REV. NO.: DOC. NO.: PAGE :	2011/11/5 A02 HLD-PSI-504 Page 2 of 5
	HBC RoHS SERIES		

额定电流 Current Rating A	尺寸 Dimensions(mm)							
	A	B1	B2	C	D	E	F	G
35A-100A	92	77.1	71.7	54	25	3.2	18	8.1
110A-200A	92	75.6	72	54	31	4.8	24	8.6
225A-400A	110	88	74.4	54	38	6.4	25.4	10.4
450-600A	110	90	74.4	54	50.8	6.4	31.8	10.4
700-800A	161	127	87.5	54	63.5	9.8	51	13.5

4.1 原材料规格 MATERIAL

品名 PART	材料 MATERIAL	备注 REMARK
触刀 Contact	黄铜 Brass	
管体 Tube	三聚氰胺玻璃布管 Melamine glass fabric tube	
可熔体 Fusible Element	银片 silver Sheet	
石英砂 Quartz Sand	二氧化硅 Silicon Dioxide	
销 Dowel	钢 Steel	
螺钉 Bolt	钢 Steel	

5. 电气特性 ELECTRICAL PERFORMANCES

5.1 测试条件 TEST CONDITIONS

全部测试条件都应在环境温度 20℃±5℃条件下进行。

All electrical tests are conducted at a ambient temperature of 20±5℃.

5.2 负载能力测试 CURRENT-CARRYING CAPACITY TEST

当熔断体通以额定电流，持续4小时以上，电路不应断开，熔断体不被电流熔断，管体不破裂。

A fuse-link shall carry rated current for four hour or more, and the circuit shall not be opened. While the fuse is carrying this current, no open circuit, melt fusible element, and ruptured tube shall occur in any manner during this test.

5.3 分断能力BREAKING CAPACITY

熔断体的分断能力应能达到下表规定的分断能力要求。熔断器分断电路后，熔断体及其部件可以改变颜色或者裂缝，但熔断体从载熔件或试验架上取出之前须保持为一整体、且其两端的绝缘电阻不小于0.1MΩ。

The breaking capacity should reach the breaking current rating given in the following table. After this test, the fuse-links or their parts may have changed their colour or may show cracks, provided that the fuse-link remains in one piece before its removal from the fuse-carrier or test rig, and the insulation resistance of both two terminals shall be not less than 0.1MΩ.

额定电压/RATED VOLTAGE	分断电流/ BREAKING CURRENT
500V AC	200KA
500V DC	50KA

 Hollyland(China)Electronics Technology Corporation Limited	PRODUCT SPECIFICATION	ISSUED DATE: 2011/11/5	A02
	HBC RoHS SERIES	REV. NO.: DOC. NO.: PAGE :	HLD-PSI-504 Page 3 of 5

5.4 技术参数(TECHNICAL PARAMETERS)

额定电流 Rated Current	功耗 WattsLoss (W)	额定电流 Rated Current	功耗 Watts Loss (W)	额定电流 Rated Current	功耗 Watts Loss (W)
35A	8	125A	25	350A	58
40A	7.5	150A	30	400A	65
45A	7.5	175A	35	450A	74
50A	7.5	200A	40	500A	84
60A	9.9	225A	39	600A	108
70A	10.6	250A	41	700A	120
80A	12.7	275A	46	800A	129
90A	15	300A	51	/	/
100A	17	325A	53	/	/

5.5 平均I-T特性曲线图(仅供参考) THE AVERAGE I-T CHARACTERISTICS CURVE (FOR REFERENCE ONLY)

HBC平均 I-T 曲线图(仅供参考)
HBC AVERAGE I-T CHARACTERISTICS CURVE
(FOR REFERENCE)

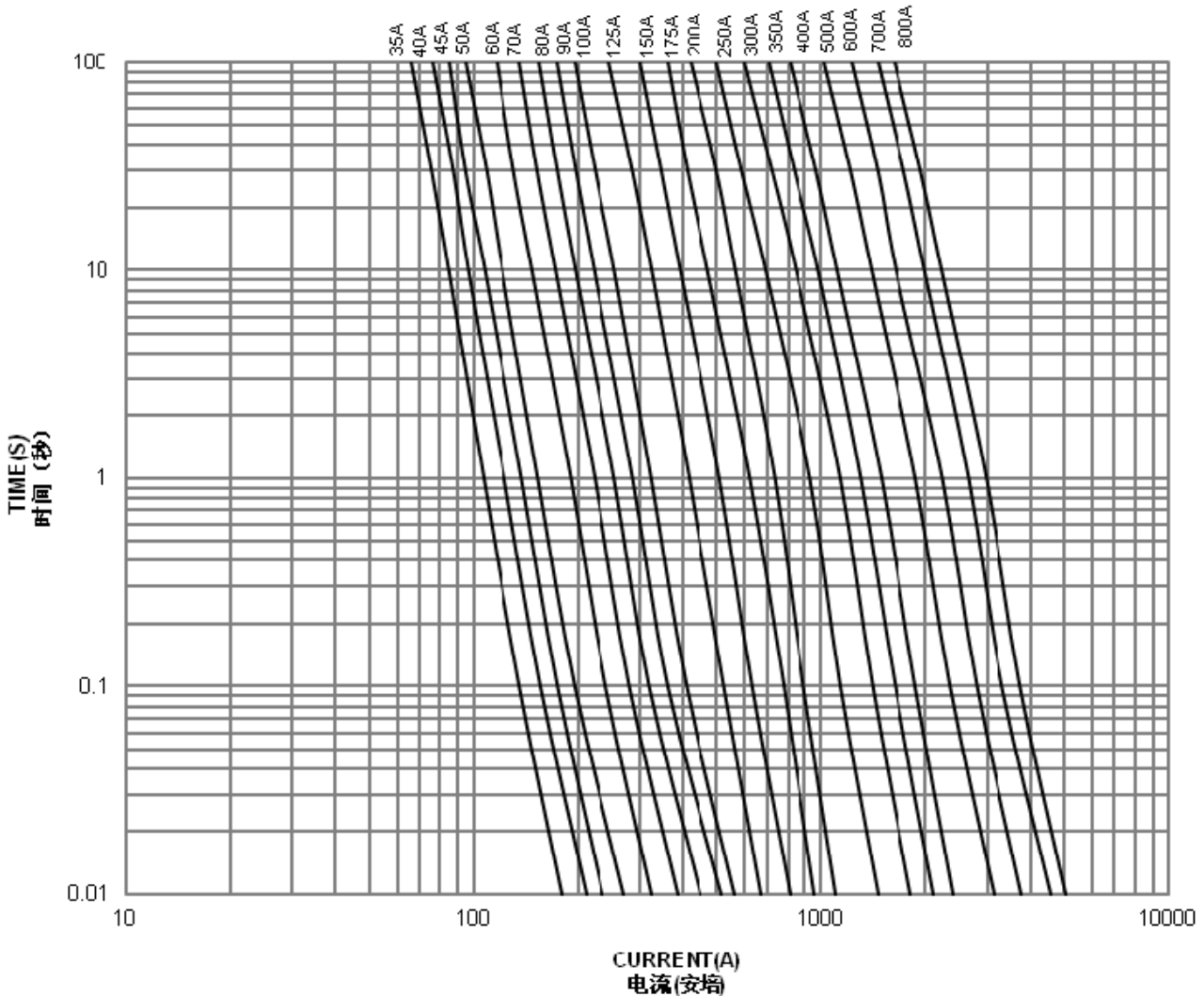



Hollyland(China)Electronics
Technology Corporation Limited

PRODUCT
SPECIFICATION

HBC RoHS SERIES

ISSUED DATE:
REV. NO.:
DOC. NO.:
PAGE :

2011/11/5
A02
HLD-PSI-504
Page 4 of 5

5.6 截断电流图(仅供参考) CUT-OFF CHARACTERISTICS (FOR REFERENCE ONLY)

HBC截断电流曲线图 (仅供参考)
HBC CUT-OFF CHARACTERISTICS CURVE (FOR REFERENCE)

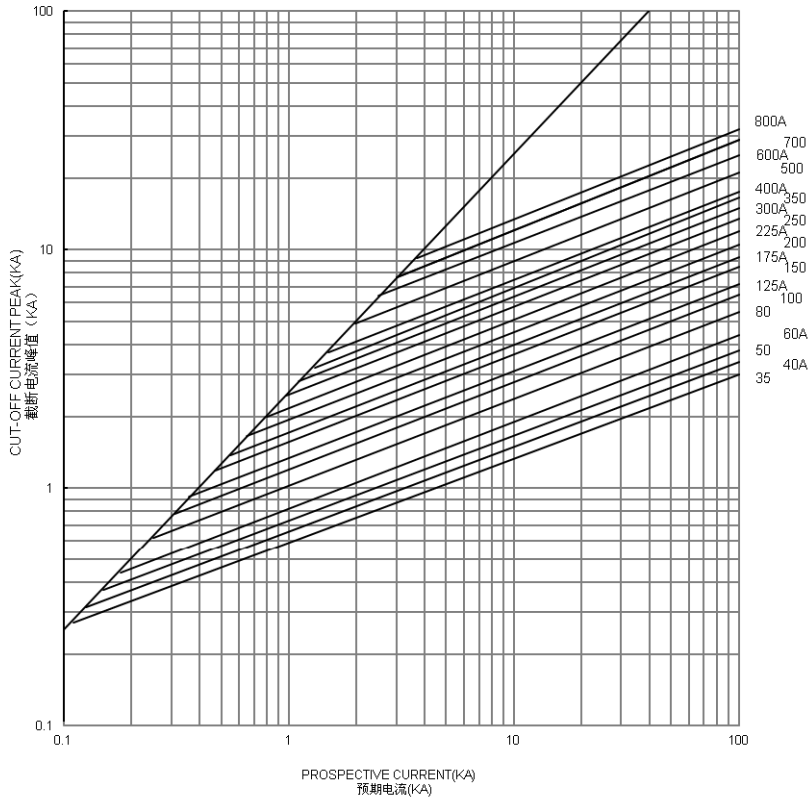

5.7 电流功耗曲线图(仅供参考):

THE AVERAGE Watts Loss vs. % Rated Current CHARACTERISTICS (FOR REFERENCE ONLY)

HBC电流功耗曲线图
HBC WATTS LOSS VS.% RATED CURRENT
(FOR REFERENCE)

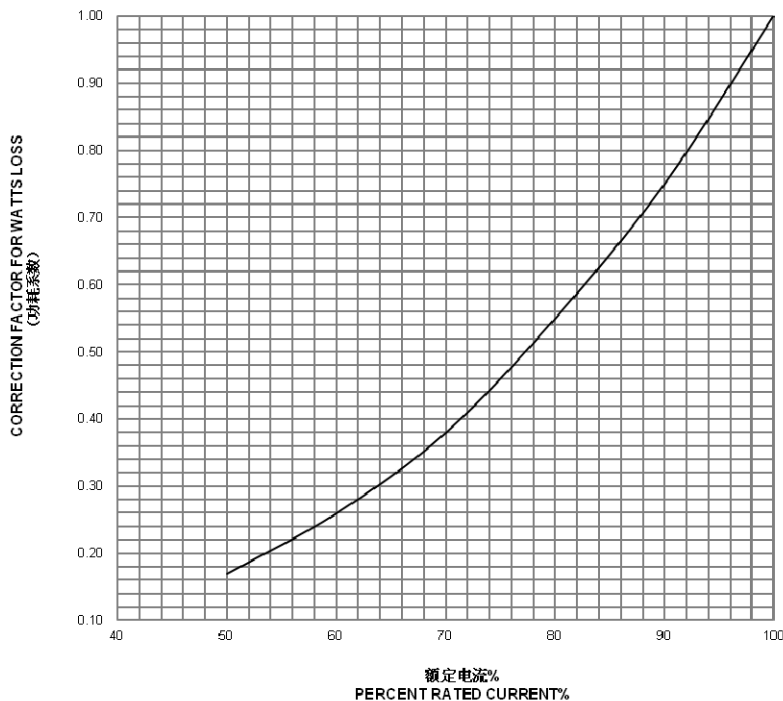

 Hollyland(China)Electronics Technology Corporation Limited	PRODUCT SPECIFICATION	ISSUED DATE: REV. NO.: DOC. NO.: PAGE :	2011/11/5 A02 HLD-PSI-504 Page 5 of 5
	HBC RoHS SERIES		

5.8 电阻测试COLD RESISTANCE TEST

环境温度为 $20\pm 5^{\circ}\text{C}$ ，测试电流不大于熔断体额定电流的10%。

Input less than or equal to 10% rated current of fuse-link to fuse for cold resistance test at the ambient temperature of $20\pm 5^{\circ}\text{C}$.

6.产品标志MARKING

6.1 熔断体上的标志应易于看清。

The relevant markings shall be marked on tube of the fuse-link and shall be easily visible.

6.2 每个熔断体应标有下列标记：The symbol for every fuse shall be as prescribed below:

6.2.1 商标Trade mark: HOLLY®

6.2.2 分断范围与使用类别Breaking range and utilization category: aR

6.2.3 额定电流Rated current:

6.2.4 额定电压Rated voltage: 500V AC/DC

6.2.5 型号标识Type mark: HBC

6.2.6 熔断器(5016)和整流器(5186)标志的组合A combination of symbols of a fuse(5016) and rectifier (5186):

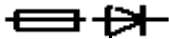

7.包装要求PACKING DETAILS

7.1 标签Label

标签应包括：型号、额定电压、额定电流、批量号码、RoHS 标志。

The label in the smallest package in which the fuse-links are put shall contain the Type, Rated voltage, Rated current, Lot. No., "RoHS" mark.

例批量号：

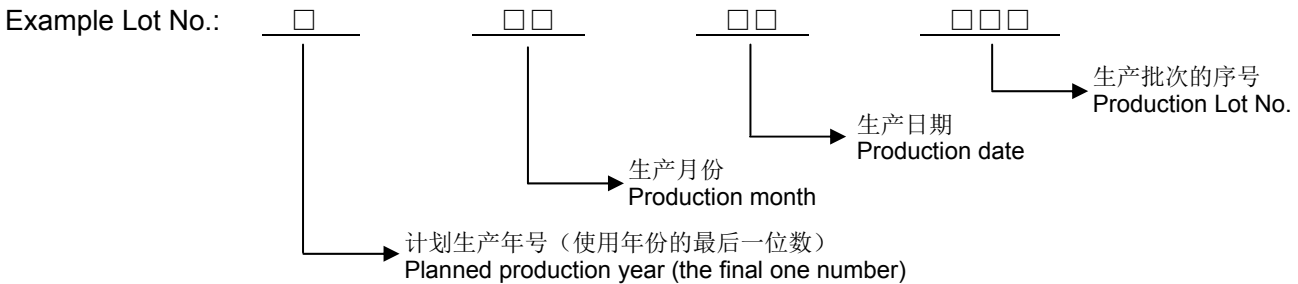

7.2 所有产品的包装应能达到防潮、抗振的作用，以防在运输或贮存过程中产品受潮或损坏。

Packing should meet the requirements of anti-moisture and anti-shaking so that the products will not absorb moisture or be damaged during transportation or storage.